

## SPECIFICATION

**Model:** BK1917-0713K30WLSG(H-H2)

### ➤ Product dimensions

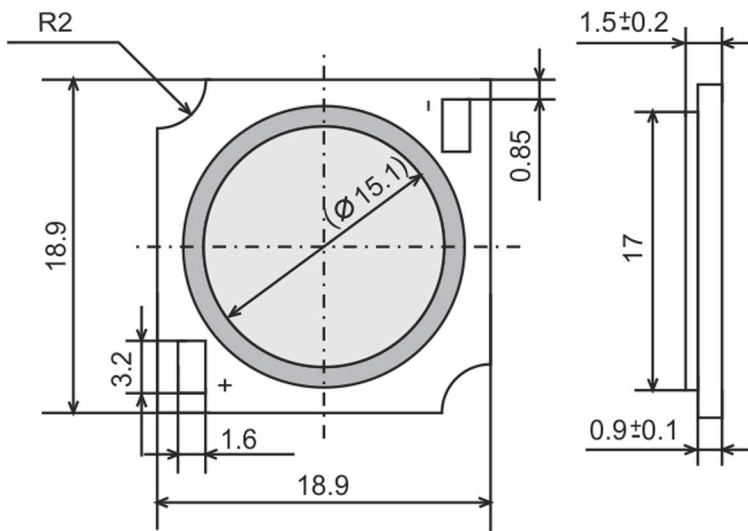

### ➤ Product characteristics

- 1) Good consistency of light color, high flux , high efficiency;
- 2) Low thermal resistance, good thermal stability;
- 3) Strong compatibility, easy to install and use;
- 4) High reliability;

## ➤ Basic parameters (T<sub>a</sub>=25°C)

	Testing Conditions	CCT	current (mA)	Luminous flux(LM)		Ra Min.	R9 Min.	thermal resistance R <sub>j</sub> (°C/W)
				Min.	Typ.			
BK1917-0713K30W LSG	T <sub>c</sub> =25°C I <sub>f</sub> : W	2700K	W800+C0	3160	3435	80	0	0.54
		3000K	-	-	-			
		3500K	-	-	-			
		4000K	W400+C400	-	-			
		4500K	-	-	-			
		5000K	-	-	-			
		5700K	-	-	-			
BK1917-0713K30W LSH-H2	(current-Warm white) C (current-Code white)	2700K	W800+C0	2668	2900	90	60	
		3000K	-	-	-			
		3500K	-	-	-			
		4000K	W400+C400	-	-			
		4500K	-	-	-			
		5000K	-	-	-			
		5700K	-	-	-			
		6000K	W0+C800	3018	3280			

Note: device tolerance 1) for luminous flux:±5%

2) Voltage±3%

3) device tolerance for color coordinate:±0.002

4) Ra/R9±2

## ➤ Limit parameters (T<sub>a</sub>=25°C)

Parameters	Symbol	Min	Typ	Max	Unit
Forward V	V <sub>f</sub>	36	36.5	42	V
Forward A	I <sub>f</sub>	-	800	1200	mA
Power	P <sub>i</sub>	-	30	50.5	W
Junction Temp	T <sub>j</sub>	-	110	150	°C
Attractions(HBM)	-	-	-	8000	V
View Angle	2θ1/2	-	120	-	degrees
Operation Temperature	T <sub>op</sub>	-10	-	+85	°C
Storage Temperature	T <sub>st</sub>	-40	-	+100	°C
welding temperature	T <sub>sol</sub>	-	-	400	°C

\*T<sub>a</sub>=25°C Bonding pad T<sub>c</sub> < 85°C. In actual condition, silica gel surface temperature of ≤130°C

## ➤ Reliability test curve

### 1、Temperature Vs Lumen

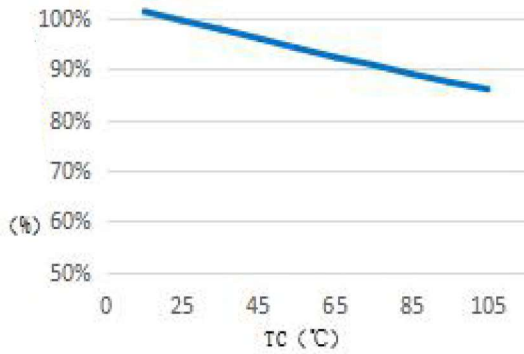

### 2、TC VS IF curve

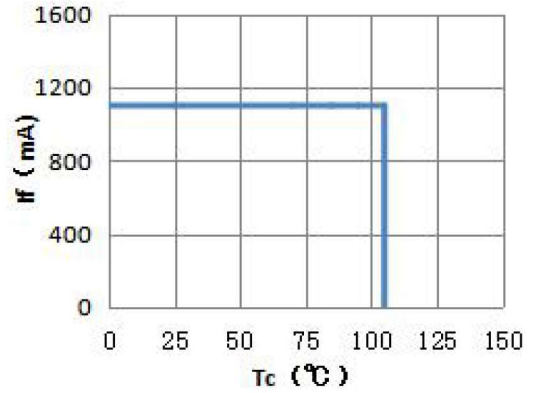

### 3、Current Vs Lumen

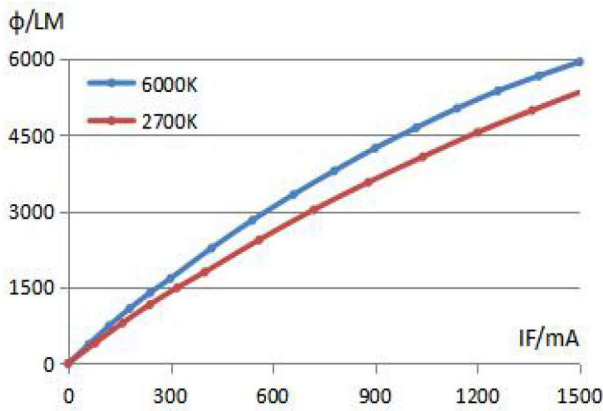

### 4、Voltage Vs Current

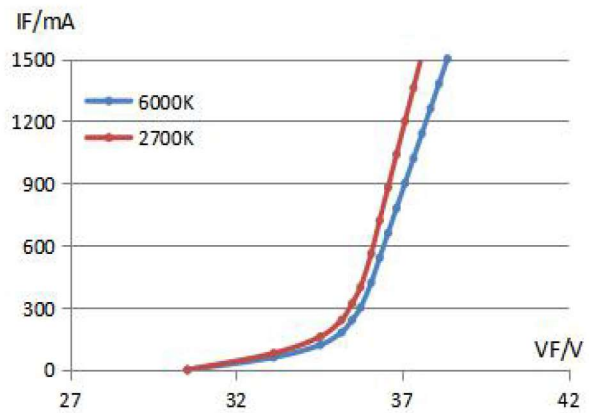

### 5、Relative spectral curve

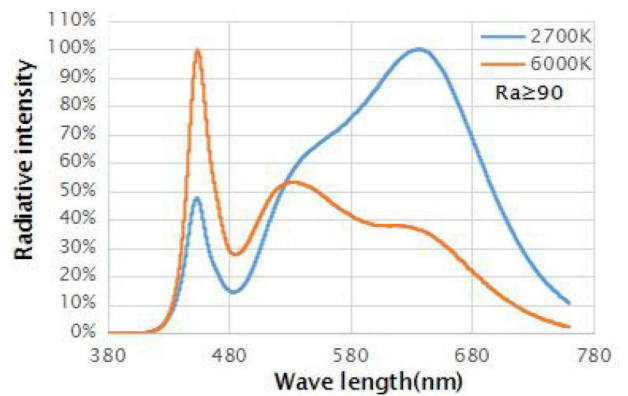
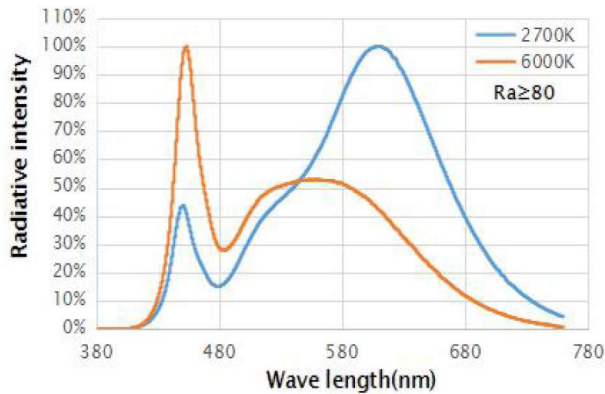

### 6.7 Light distribution diagram

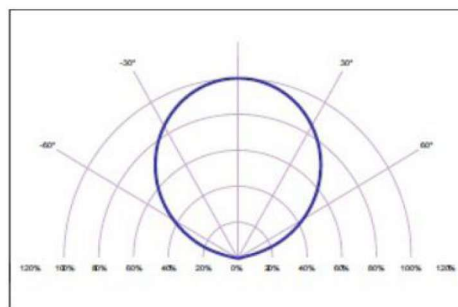
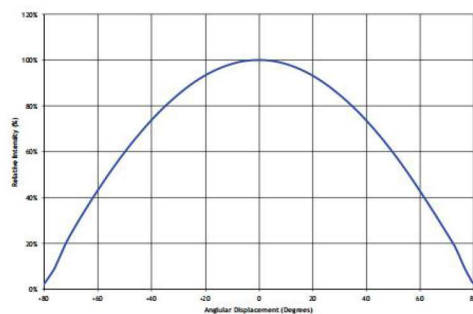

➤ **White bins on CIE-1931 ( Ta=25°C)**

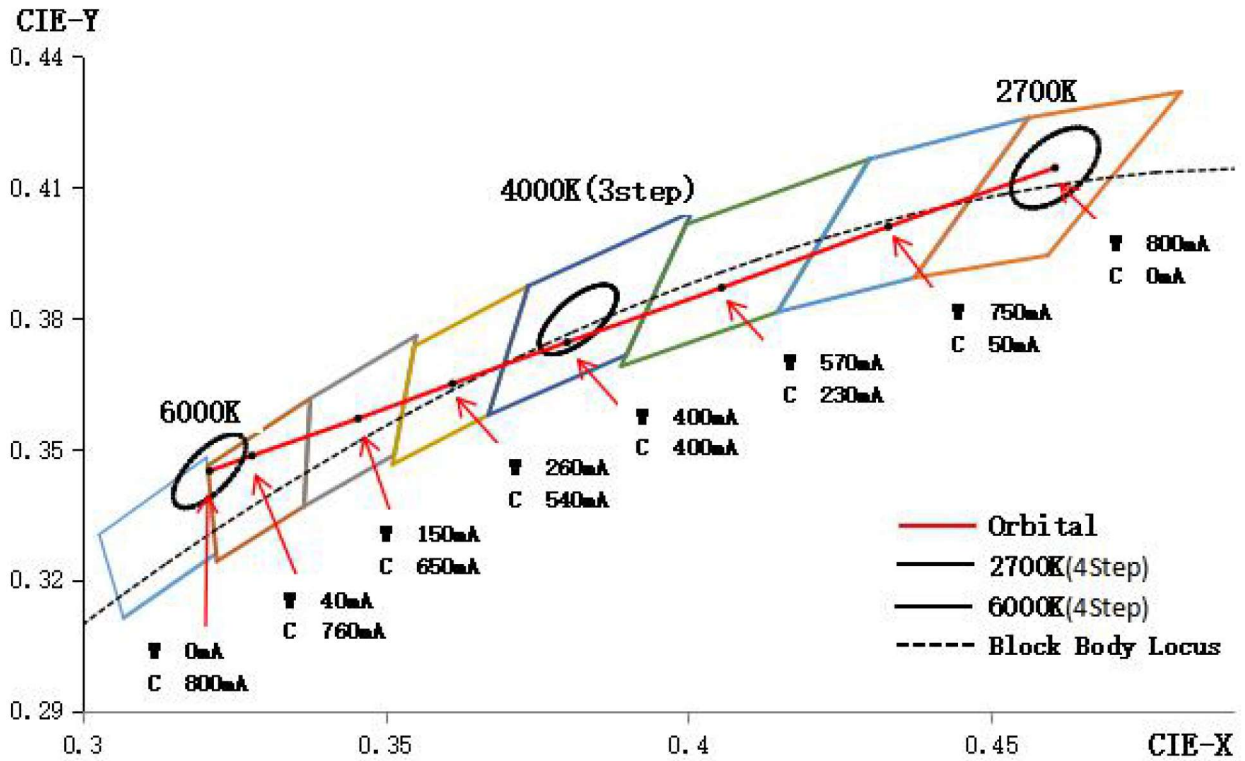

**BIN Color Temperature and BIN**

CT	2700K	6000K
CT Range	2600-2800	5700-6300
CT Factor	±100	±300
Bin NO.	L4	S4

CCT	chromaticity tolerances	Central point coordinates		long axisa	Short axis b	Rotation Angle $\Theta$
		X	Y			
2700K	4SDCM	0.4605	0.4145	0.01032	0.00548	57.28
6000K		0.321	0.345	0.0096	0.00388	58.60

Product color sorting test according to standard current, if using with other current, light/color will change.

If customers need specific IEC standards, please let us know before placing an order. We will adjust the standards to meet your special requirements.

## ➤ Package and label illustration

1) COB Packing : Tray + Anti-static bag with vacuum packing + outer boxes

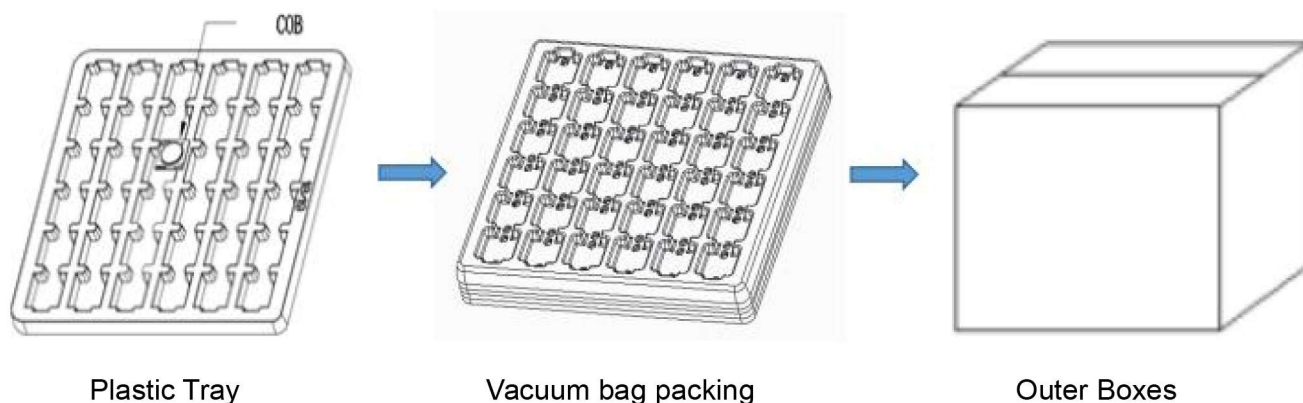

2) Box dimensions

Box Size	Length ( mm )	Width ( mm )	Height ( mm )
Big	38.5	38.5	23
Medium	33	23	19

3) COB

PN base	PCS/BOX	Tray/bag	Pcs/bag	Bag/ pcs Big box	bag/Pcs/Medium box
BK1306/BK1375/BK1308	36	5	180	24/4320	10/1800
BK16105/BK1611	30	5	150	24/3600	10/1500
BK1814/BK1914/BK1917	25	5	125	24/3000	10/1250
BK28245	16	5	80	26/2080	10/800

4) Coding rules for the back printing of COB

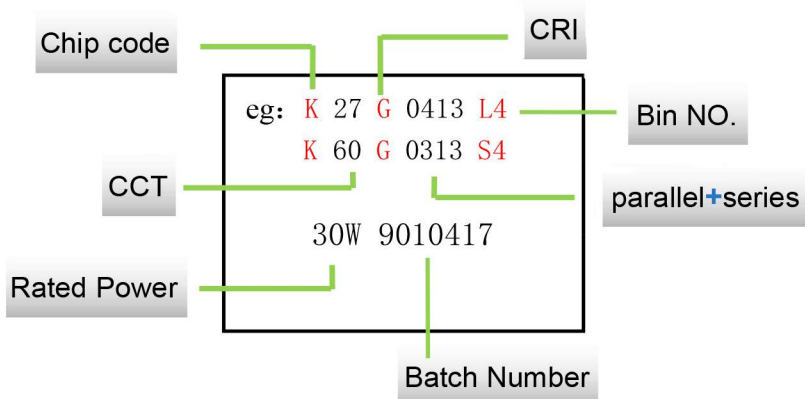

## ➤ Coding rules

B H13 11-04 12 J 12W 30 G-KV3X

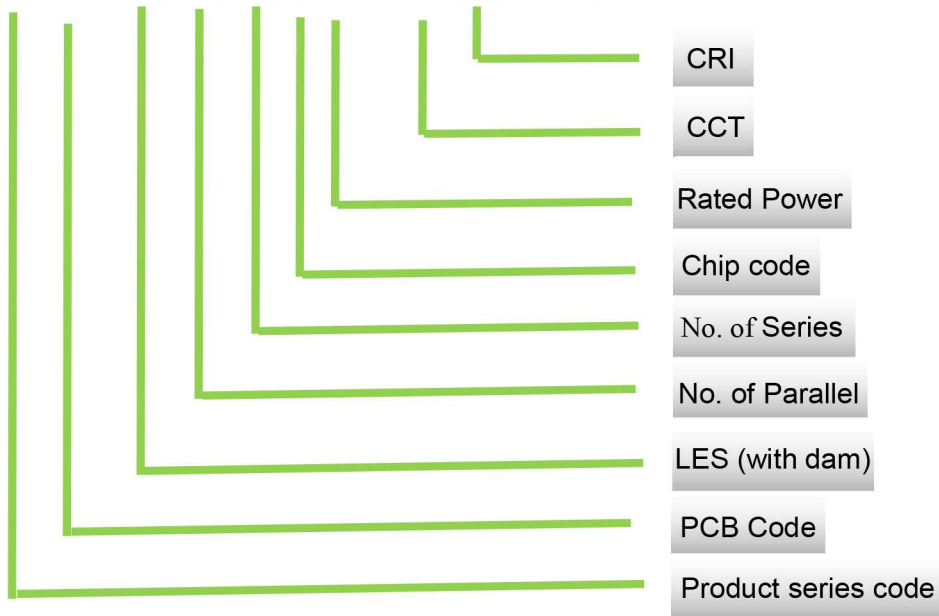

## ➤ Test items

Type	Test items	standards	Test conditions	duration	Sample quantity	result
Environment test	Temp. cycle	JEITA ED-4701 100 105	-40°C→25°C→ 100°C→25°C 30Min 5Min 30Min 5Min	300 (300 cycles)	5	0/5
	Storage with high temp	JEITA ED-4701 200 201	Ta=100°C	168 hrs	5	0/5
	Storage with low temp	JEITA ED-4701 200 202	Ta=-40°C	168 hrs	5	0/5
Life test	room temp	-	Ta=25°C @If	1000/3000/600 0 hrs	1	0/1
	high temp	-	Ta=85°C @If	1000 hrs	1	0/1
	high temp and high humidity	-	Ta=85°C Rh=85% @If	1000 hrs	1	0/1
	High power with Room Temp	-	@1.5*If	720 hrs	1	0/1
	Soldering resistance	IEC62717	@If Tc=85°C 30s on/30s off	30000cycle	2	0/2

## ➤ Announcements

### 1) Storage condition

The storage environment humidity is <60%, the temperature is maintained at 20°C-30°C. Once the COB light sources have been unsealed, please install them within 168H; if it is not used up within 168H, please vacuum it and keep it sealed. After sealing, the effective use period is 1 year.

### 2) Application notice

When welding, the soldering iron should be properly grounded. When manual welding, the temperature of the iron must be lower than 400°C, welding time shall not exceed 3 seconds and shall be cooled to room temperature before welding again. When welding, no external force should be put on the colloidal surface and the surrounding dam glue (such as pressure, friction or sharp metal nails, etc.) or it will cause deformation of gold wire or broken wire...

In order to reduce the contact thermal resistance during assembling, please note that the thermal conductivity paste coating is uniform with proper distribution area, too little thermal conductivity paste or uneven application level is not okay. When using thermal conductive rubber pad, make sure that the base plate and thermal conductive rubber pad are in complete contact after screw installation, No hollow space is allowed.

After welding, please do not let the heat conduction silicon grease, oil... to the luminous surface, dirt can be removed with an air gun, do not use sulfur, chlorine element liquid or washing board water to clean, Air gun pressure: 0.5mpa, time 1-2 seconds, distance: more than 20cm apart.

### 3) Electrostatic protection

This product is sensitive to static electricity, so effective protective measures must be taken when using this product to effectively prevent the damage of LED light source from static electricity and surge. When the high voltage current generated by static electricity exceeds the maximum rating of LED light source, the LED light source will be damaged or even completely invalid. Therefore, Customers should take effective measures to prevent static electricity and surge when using the products. Suggested grounding resistance is 10Ω or less.

### 4) Over-temperature, over current protection

Do not press the luminous silicon surface at any time to avoid bad effect or even ineffective to the COB. It is recommended to design grounding circuit for the whole lamp design.

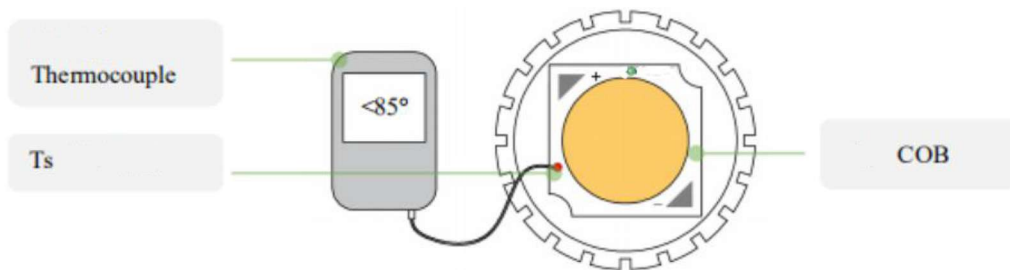

The working humidity is between 50% and 80%, and the working environment is between -10°C and 85°C, otherwise, there will be hidden dangers of electrostatic breakdown and large current impact. When using this product, please ensure that it is used within the maximum rating (maximum current and  $T_c$  and glue surface temperature) specified in this specification. Any adverse consequences arising from failure to comply with the maximum rating and description of the product specifications shall not be covered by the warranty.

### 5) Thermal design

A good use effect of LED light source depends on the thermal resistance of LED light source, external thermal resistance, power loss and ambient temperature.

High junction temperature of LED will affect the light flux and the working life of the light source. Full consideration of these factors is highly recommended in heat dissipation design.