

SPECIFICATION

Model: BH1917-0812J24W**-KV3

➤ Product dimensions

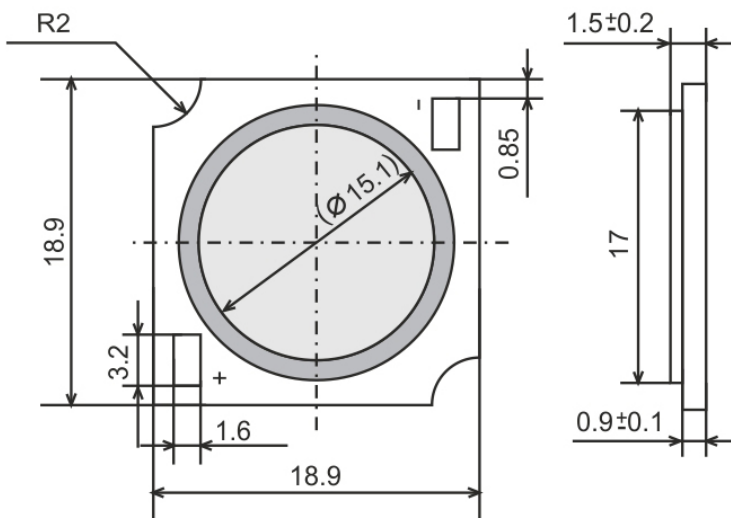

Unit : mm, tolerance±0.2 unless stated otherwise

➤ Product characteristics

- 1) Good consistency of light color, high flux , high efficiency;
- 2) Low thermal resistance, good thermal stability;
- 3) Strong compatibility, easy to install and use;
- 4) High reliability;
- 5) LM-80 Certified and applied with RoHS standard
- 6) ANSI standards

➤ Basic parameters (T_J=85°C)

Model	CCT	Ra	R9	Luminous flux(LM)			Typ. Lumens (LM/W)	Typ. current (mA)	thermal resistance R _j (°C/W)
		Min.	Min.	T _J =85°C		T _C =25			
				Min.	Typ.	Typ.			
BH1917-0812J24W27G-KV3	2700K	80	0	3017	3279	3643	134	720	0.32
BH1917-0812J24W30G-KV3	3000K	80	0	3175	3452	3835	141	720	0.32
BH1917-0812J24W35G-KV3	3500K	80	0	3271	3555	3950	145	720	0.32
BH1917-0812J24W40G-KV3	4000K	80	0	3398	3693	4103	151	720	0.32
BH1917-0812J24W50G-KV3	5000K	80	0	3398	3693	4103	151	720	0.32
BH1917-0812J24W57G-KV3	5700K	80	0	3366	3659	4065	149	720	0.32
BH1917-0812J24W65G-KV3	6500K	80	0	3334	3624	4027	148	720	0.32
BH1917-0812J24W27H-KV3	2700K	90	50	2534	2754	3060	113	720	0.32
BH1917-0812J24W30H-KV3	3000K	90	50	2667	2899	3221	118	720	0.32
BH1917-0812J24W35H-KV3	3500K	90	50	2734	2972	3302	121	720	0.32
BH1917-0812J24W40H-KV3	4000K	90	50	2867	3117	3463	127	720	0.32
BH1917-0812J24W50H-KV3	5000K	90	50	2881	3131	3479	128	720	0.32
BH1917-0812J24W57H-KV3	5700K	90	50	2881	3131	3479	128	720	0.32
BH1917-0812J24W65H-KV3	6500K	90	50	2934	3189	3544	130	720	0.32

Note: device tolerance 1)for luminous flux:±5%

2) Voltage±3%

3) device tolerance for color coordinate:±0.002

4) Ra/R9±2

➤ Limit parameters (T_a=25°C)

Parameters	Symbol	Min	Typ	Max	Unit
Forward V(T _J =85°C)	V _f	32	34	38	V
Forward A	I _f	-	720	1840	mA
Power (T _J =85°C)	P _i	-	24	69.92	W
Junction Temp	T _j	-	110	125	°C
Attractions(HBM)	-	-	-	8000	V
View Angle	2θ1/2	-	120	-	degrees
Operation Temperature	Top	-10	-	+85	°C
Storage Temperature	T _{st}	-40	-	+100	°C
welding temperature	T _{sol}	-	-	350	°C

*T_a=25°C, T_c≤85°C;

*T_a=25°C Bonding pad T_c < 85°C. In actual condition, silica gel surface temperature of ≤130°C

➤ Reliability test curve

1、Temperature Vs Lumen

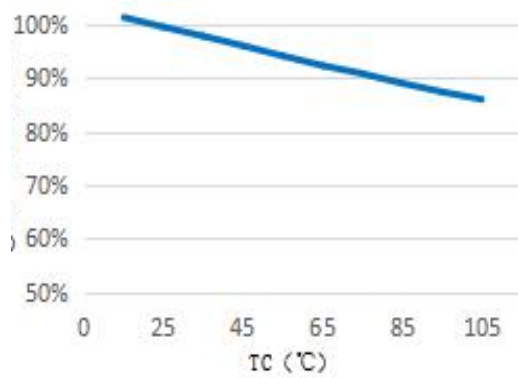

2、TC VS IF curve

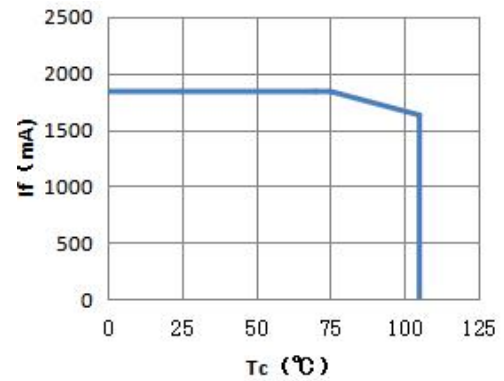

3. Current Vs Lumen

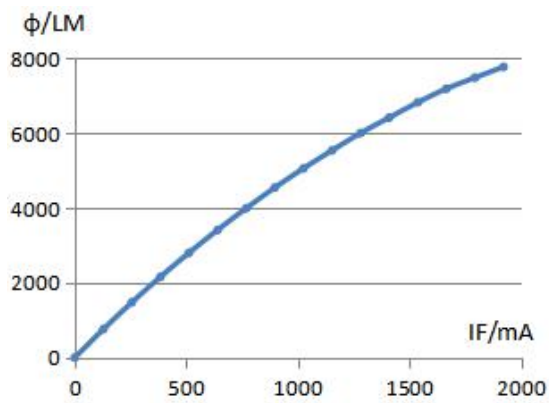

4. Voltage Vs Current

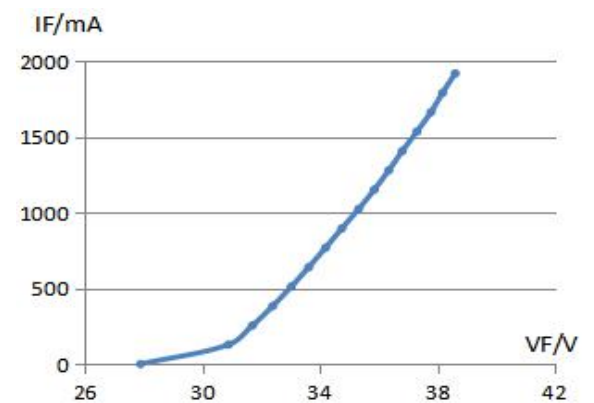

5. Relative spectral curve

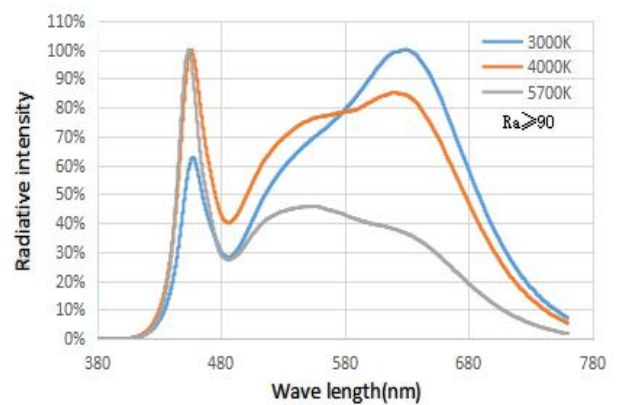
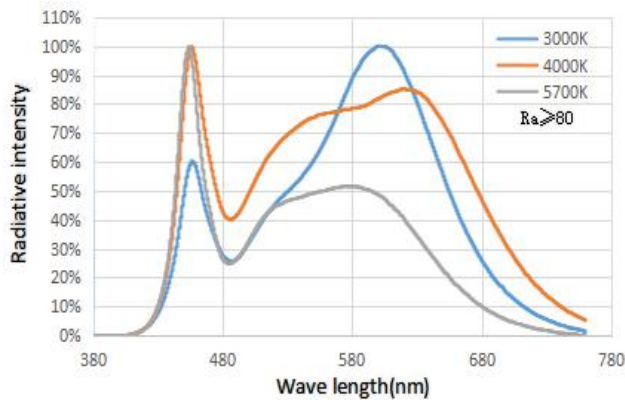

6.7 Light distribution diagram

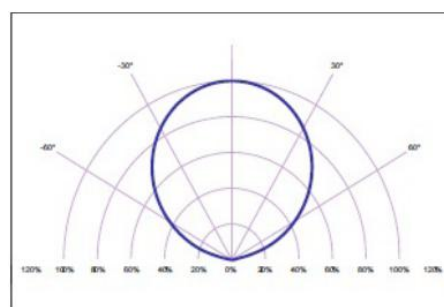
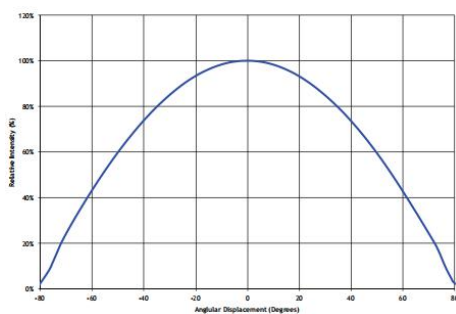

➤ **White bins on CIE-1931 (Ta=25°C)**

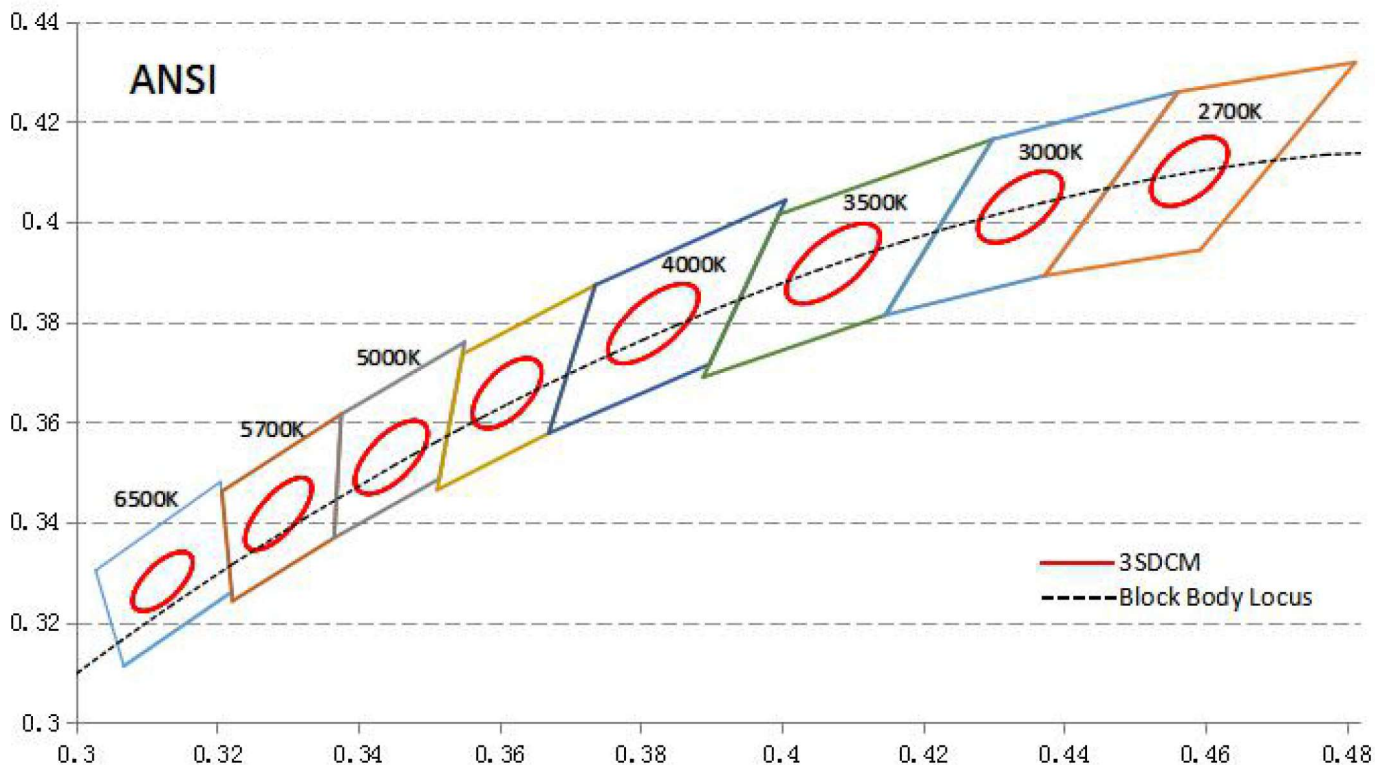

BIN Color Temperature and BIN

CT	2700K	3000K	3500K	4000K	4500K	5000K	5700K	6500K
CT Range	2660-2790	2970-3125	3350-3575	3850-4110	4350-4640	4835-5235	5440-5920	6250-6850
CT Factor	±65	±77.5	±112.5	±130	±145	±200	±240	±300
Bin NO.	L3	M3	N3	O3	P3	Q3	R3	T3

CCT	chromaticity tolerances	Central point coordinates		long axis a	Short axis b	Rotation Angle Θ
		X	Y			
2700K	3SDCM	0.4578	0.4101	0.00774	0.00411	57.28
3000K		0.4338	0.403	0.00834	0.00408	53.17
3500K		0.4073	0.3917	0.00951	0.00417	52.97
4000K		0.3818	0.3797	0.00939	0.00402	54.00
5000K		0.3447	0.3553	0.00822	0.00354	59.62
5700K		0.3287	0.3417	0.0081	0.003	61.00
6500K		0.3123	0.3282	0.00669	0.00285	58.38

Product color sorting test according to standard current, if using with other current, light/color will change.

If customers need specific IEC standards, please let us know before placing an order. We will adjust the standards to meet your special requirements.

➤ Package and label illustration

1) COB Packing : Tray + Anti-static bag with vacuum packing + outer boxes

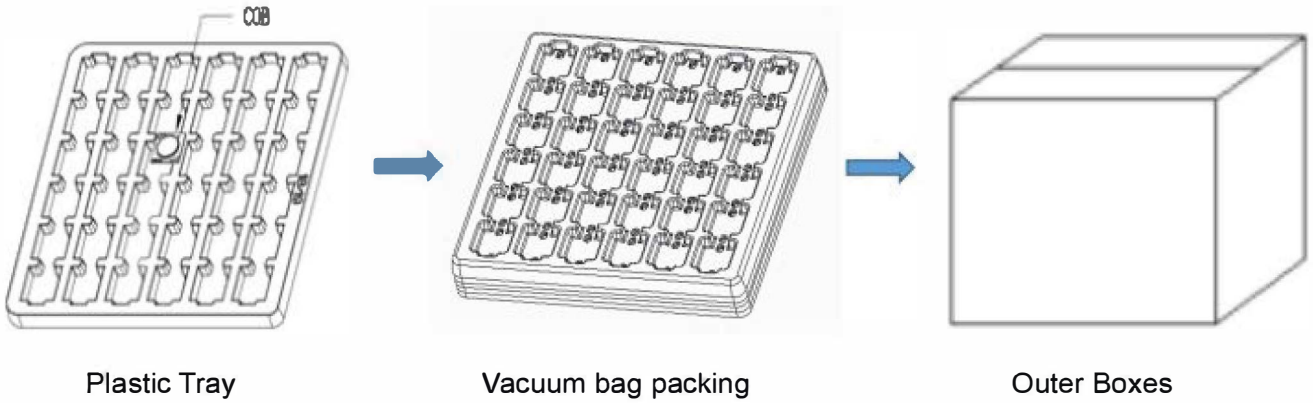

2) Box dimensions

Box Size	Length (mm)	Width (mm)	Height (mm)
Big	38.5	38.5	23
Medium	33	23	19

3) COB

PN base	PCS/BOX	Tray/bag	Pcs/bag	Bag/ pcs Big box	bag/Pcs/Medium box
BH1375/BH1311	36	5	180	24/4320	10/1800
BH1675/BH16105	49	5	245	30/7500	13/3185
BH1814/BH1816/BH1917	25	5	125	24/3000	10/1250
BH2321	25	5	125	26/3250	10/1250
BH28245	16	5	80	26/2080	10/800
OH3835/OH46248	9	5	45	24/1080	10/450

4) Coding rules for the back printing of COB

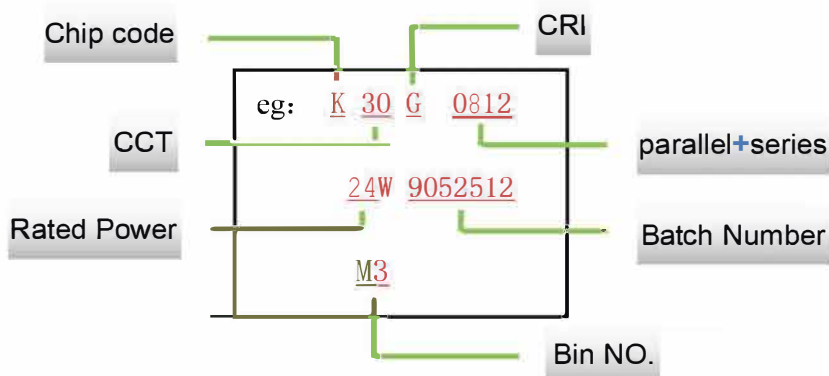

➤ Coding rules

B H19 17-08 12 J 24W 30 G-KV4X

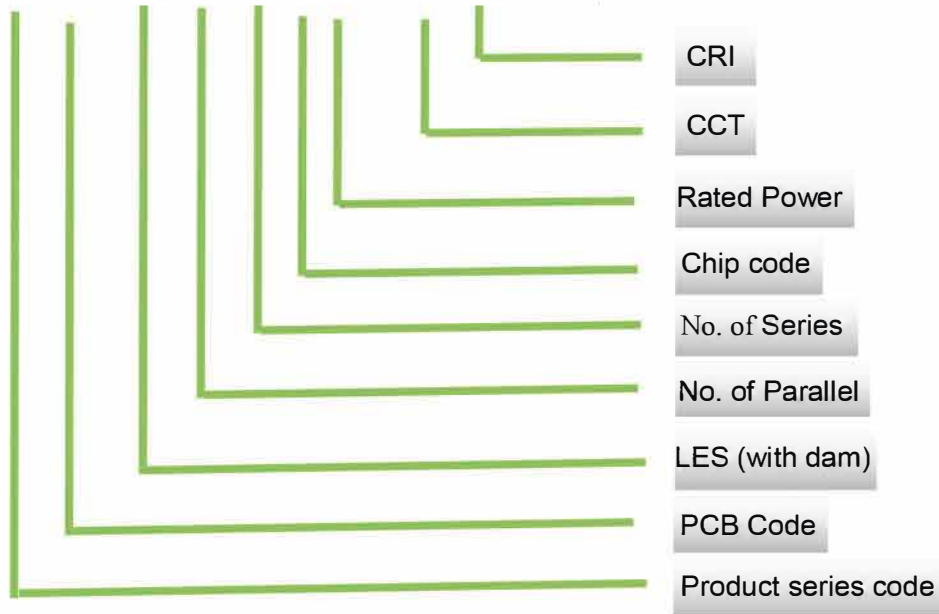

➤ Test items

Type	Test items	standards	Test conditions	duration	Sample quantity	result
Environment test	Temp. cycle	JEITA ED-4701 100 105	-40°C→25°C→ 100°C→25°C 30Min 5Min 30Min 5Min	300 (300 cycles)	5	0/5
	Storage with high temp	JEITA ED-4701 200 201	Ta=100°C	168 hrs	5	0/5
	Storage with low temp	JEITA ED-4701 200 202	Ta=-40°C	168 hrs	5	0/5
Life test	room temp	-	Ta=25°C @If	1000/3000/600 0 hrs	1	0/1
	high temp	-	Ta=85°C @If	1000 hrs	1	0/1
	high temp and high humidity	-	Ta=85°C Rh=85% @If	1000 hrs	1	0/1
	High power with Room Temp	-	@1.5*If	720 hrs	1	0/1
	Soldering resistance	IEC62717	@If Tc=85°C 30s on/30s off	30000cycle	2	0/2

➤ Announcements

1) Storage condition

The storage environment humidity is <60%, the temperature is maintained at 20°C-30°C. Once the COB light sources have been unsealed, please install them within 168H; if it is not used up within 168H, please vacuum it and keep it sealed. After sealing, the effective use period is 1 year.

2) Application notice

When welding, the soldering iron should be properly grounded. When manual welding, the temperature of the iron must be lower than 350°C, welding time shall not exceed 3 seconds and shall be cooled to room temperature before welding again. When welding, no external force should be put on the colloidal surface and the surrounding dam glue (such as pressure, friction or sharp metal nails, etc.) or it will cause deformation of gold wire or broken wire...

In order to reduce the contact thermal resistance during assembling, please note that the thermal conductivity paste coating is uniform with proper distribution area, too little thermal conductivity paste or uneven application level is not okay. When using thermal conductive rubber pad, make sure that the base plate and thermal conductive rubber pad are in complete contact after screw installation, No hollow space is allowed.

After welding, please do not let the heat conduction silicon grease, oil... to the luminous surface, dirt can be removed with an air gun, do not use sulfur, chlorine element liquid or washing board water to clean, Air gun pressure: 0.5mpa, time 1-2 seconds, distance: more than 20cm apart.

3) Electrostatic protection

This product is sensitive to static electricity, so effective protective measures must be taken when using this product to effectively prevent the damage of LED light source from static electricity and surge. When the high voltage current generated by static electricity exceeds the maximum rating of LED light source, the LED light source will be damaged or even completely invalid. Therefore, Customers should take effective measures to prevent static electricity and surge when using the products. Suggested grounding resistance is 10Ω or less.

4) Over-temperature, over current protection

Do not press the luminous silicon surface at any time to avoid bad effect or even ineffective to the COB. It is recommended to design grounding circuit for the whole lamp design.

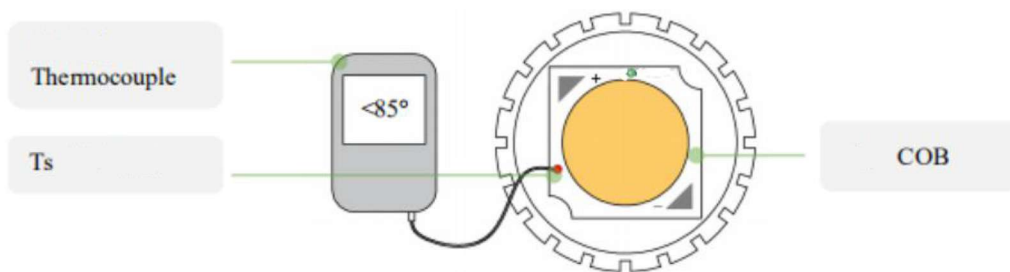

The working humidity is between 50% and 80%, and the working environment is between -10°C and 85°C, otherwise, there will be hidden dangers of electrostatic breakdown and large current impact. When using this product, please ensure that it is used within the maximum rating (maximum current and T_c and glue surface temperature) specified in this specification. Any adverse consequences arising from failure to comply with the maximum rating and description of the product specifications shall not be covered by the warranty.

5) Thermal design

A good use effect of LED light source depends on the thermal resistance of LED light source, external thermal resistance, power loss and ambient temperature.

High junction temperature of LED will affect the light flux and the working life of the light source. Full consideration of these factors is highly recommended in heat dissipation design.